

VEES PREMIUM

GAS COOKER

INSTRUCTION MANUAL

VGH-228 2B-BK

Please read the instruction manual
carefully before using gas cooker

TROUBLESHOOTING

No	Situation	Solution
1	There is no flame when I push down the turn knob	<ol style="list-style-type: none"> When you start to use the cooker for the first time or the cooker has not been used for a long period of time, it sometimes happens that the burner is ignited easily. This is because the gas needs to fill up the gas hose before reaching to the burners Please ensure there is gas in the gas tank Please check whether battery is dead Please press and hold the turn knob for 5 seconds before you release it Please check you have install the burner correctly
2	Uneven or abnormal flame	<ol style="list-style-type: none"> Please ensure the burner is installed correctly; uneven flame or abnormal flame can be seen if burner was not install correctly
3	Yellow or red flame, burning black smoke, floating flame or deposit of black soot underneath cooking utensils	<ol style="list-style-type: none"> It is normal to have a slight amount of yellow flame. This would indicate incorrect proportion of air and gas mixture. To correct: <ol style="list-style-type: none"> Please check you have sufficient gas in your gas tank You can adjust the amount of air supply to the gas cooker by adjusting the air regulator in the following way: <ol style="list-style-type: none"> Move the regulator up or down to allow a greater or lesser flow of air and adjust until a blue flame is achieved. You can try to clean the burner as food residue that reside in the burner might lead too much yellow or red flame
4	Burner discolored or turn white after usage	<ol style="list-style-type: none"> It is normal as constant high heat might cause the burner to discolor, it will not affect the usage of the cooker
5	Smell of gas	<ol style="list-style-type: none"> It might due to gas leaking, please check your gas hose for any breakage or crack line Please check your gas hose is firmly clam to the gas supply outlet

If the above problem persists, turn off the cooker immediately and please contact our customer service.

MAIN SPECIFICATION

Model	Gas Type	Gas Category	Gas Pressure	Product Dimension(mm)	Built-in Dimension(mm)	Heat Efficiency	Appliance name
VGH-228 20-BA	Butane, propane or their mixture Gas Pressure	I3B/P(30)	3000Pa	730(W)X410(D)	630x320	Left:>52% Right:>52%	Gas hob

REMOVE ALL PACKING MATERIALS FROM THIS PRODUCT BEFORE USING IT. THIS APPLIANCE MUST BE INSTALLED ON A FLAT SURFACE. PLEASE ENSURE THE GAS SUPPLY TO THIS APPLIANCE IS DISCONNECTED BEFORE INSTALLING.

THIS APPLIANCE SHALL BE INSTALLED IN ACCORDANCE WITH THE REGULATIONS IN FORCE AND ONLY USED IN A WELL VENTILATEDSPACE. READ THE INSTRUCTIONS BEFORE INSTALLING OR USING THIS APPLIANCE.

Please read this instruction carefully. It is advisable to keep this instruction manual in a safe place for future reference.

SAFETY PRECAUTIONS

- PRIOR TO INSTALLATION, ENSURE THAT THE LOCAL DISTRIBUTION CONDITIONS (NATURE OF THE GAS AND GAS PRESSURE) AND THE ADJUSTMENT OF THE APPLIANCE ARE COMPATIBLE.
- THE ADJUSTMENT CONDITIONS FOR THIS APPLIANCE ARE STATED ON THE LABEL (OR DATA PLATE).
- THIS APPLIANCE IS NOT CONNECTED TO A COMBUSTION PRODUCTS EVACUATION DEVICE. IT SHALL BE INSTALLED AND CONNECTED IN ACCORDANCE WITH CURRENT INSTALLATION REGULATIONS. PARTICULAR ATTENTION SHALL BE GIVEN TO THE RELEVANT REQUIREMENTS REGARDING VENTILATION.
- Keep cooking appliance out of reach from children. Do not let them to operate the appliances without supervision.
- To protect against the risk of fire, do not expose the appliance under direct sunlight or place near to flammable materials.
- This product is for household and indoor use only.
- This product is not intended for use by person (including children) with reduced physical, sensory or mental capabilities unless they have been given supervision or instruction concerning use of the appliance by a person responsible for their safety.
- If the gas pipe or connector is damaged, it must be replaced immediately to avoid hazard.
- Be sure to turn off the gas supplies and main cock if the unit is not in use.

WARNING - to reduce the risk of fire or injury to persons or property, please read and follow below instructions carefully:

- Always operate the product from a source of the same gas pressure as indicated on the product identification marking.
- Do not operate this product if it has malfunctioned, damaged hose or connector or appears damaged in any way. Return the complete product to the place of purchase for inspection, repair or replacement.
- This product should not be used in the place where high flammable material is stored.
- Always turn off the gas supply from the gas tank when not in use, before assembling or disassembling parts and before cleaning. Fully assemble the set before operating.
- Make sure all the burners are well positioned before operating the set. Do not operate the set if the burners are not positioned properly.
- Always disconnect the gas source when moving the appliance from one location to another.
- In case of gas leakage, turn off the main cock and ventilate the room immediately by opening the windows and doors. Do not attempt to turn the wall switch of fans or other electrical appliances on or off.

PRODUCT DESCRIPTION

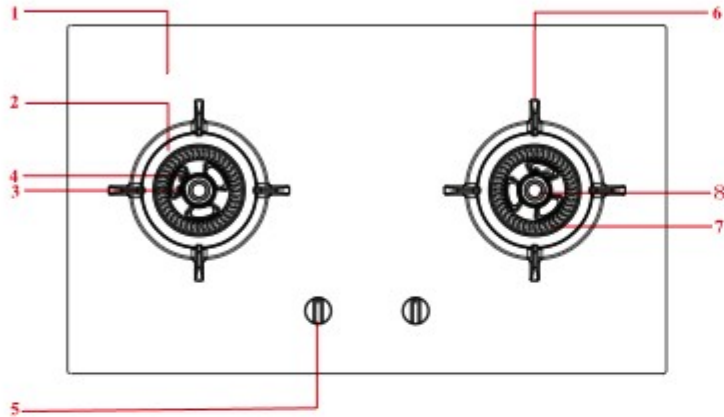

1. Glass Panel
2. Gravy Tray
3. Thermocouple
4. Ignition Point
5. Ignition Knob
6. Pan Support
7. Outer burner Cap
8. Inner burner Cap

ADDITIONAL INFO (SAFETY CLAUSES)

Consistently cleaning the blocked burner hole to prevent backfire. During cooking, prevent the gravy from over flooding the gravy tray.

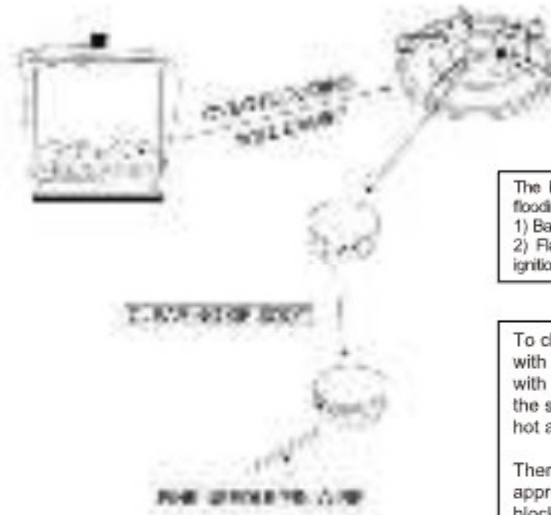

The burner hole is blocked by gravy due to over flooding. It will lead to:
1) Back fire may cause breakage of glass .
2) Flame will extinguish or unable to maintain its ignition

To clean the inner burner cap which is blocked with gravy or soot, please wash the cap with water to clean up the gravy covered on the surface. (Don't wash when the cap is hot after using).

Then use a fine needle, pin or wire, (size approx. $\leq 1\text{mm}$) to clean the hole that is still blocked with gravy or soot. Fit back the cap when it is completely dry.

In case of the above negligence and subsequent that lead to glass broken, the company will not be liable for any claims on the losses.

NOTICE



This product must not be disposed together with domestic waste. It has to be disposed at an authorized place for recycling of electrical and electronic appliances. By collecting and recycling waste, you help to save natural resources and make sure the product is disposed in an environmental friendly and healthy way.



CLEANING AND MAINTENANCE

Before cleaning, make sure the cooker is cool and the gas supply is switched off. Clean the cooker with a damp cloth with mild cleaner. Do not use chemical, steel, wooden or abrasive cleaners to clean the cooker.

WARNING: DO NOT IMMERSE THE COOKER INTO WATER. ENSURE THAT THE SET IS DISCONNECTED FROM THE GAS SUPPLY BEFORE CLEANING.

UNIT PARTS	MAINTENANCE
Burner cap	<ul style="list-style-type: none"> Check if the gap in the ring caps are clogged with dirt. Clean them with a sharp object, wire brush, toothbrush, or similar object. After washing the burner caps, dry them. 
Burners, Burner cap, Pan support	<ul style="list-style-type: none"> Make sure the cap is mounted in place (if the burner caps are not mounted properly, gas distribution may not be even.) 
Cook top and Control panel	<ul style="list-style-type: none"> When they get dirty, use a soft cloth dampened with a mild detergent solution to wipe off dirt. Do not use thinner or benzene for cleaning. This may damage plastic parts.
Gas hose	<ul style="list-style-type: none"> Make sure the gas hose is tightly secured over gas supply outlet and secure it with the clamp. If there are cracks in the hose, replace it immediately.
Cook top	<ul style="list-style-type: none"> Please use a soft cloth to wipe off any dirt or stain on the cook top. Make sure to wipe off any dirt or stain as soon as possible else, it might become hard to remove and might even cause damage to the cook top coating material. If the dirt or stain is difficult to remove, you can use a soft dampened cloth with neutral detergent solution. The cook top coating material is vulnerable against physical force or high temperature. Therefore the following MUST be kept in mind: <ol style="list-style-type: none"> DO NOT use swab, polishing powder, cleanser, knife, alkaline detergent or bleaching solution to clean off any dirt or stain. DO NOT expose cooker to any physical force. DO NOT expose cooker to excessive heat by covering the burner with a large iron plate or large pot. It is normal that after usage: <ol style="list-style-type: none"> gravy tray or pan support will be scratched burner might discolour or turn to white surface after constant high heat all the above situations will not affect the usage of the gas cooker

ASSEMBLY INSTRUCTIONS

- Remove all packaging material from the product.
- Make sure to install the cooker in the room with no strong air flow.
- Allow at least 15cm of space from kitchen walls, 100cm from the ceiling and 40cm below the glass stove.

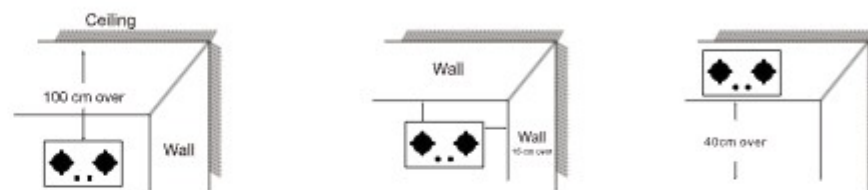

- Make sure the cooker is installed in the level position.
- If the kitchen walls and cabinet are made of wood or any combustible material and the spaces as specified cannot be maintained, you must install a heat-proof panel on the kitchen wall so as to prevent possible fire hazard.
- Open the battery box at the bottom of the cooker, and install the battery according to the correct polarity. Then close the battery box.
- Lay the cooker in the kitchen cabinet. Place the gravy tray and other parts in the correct position.
- Install the gas hose with the stainless steel hose clamp. Use only approved gas hose and the length of not more than 2m. Do not bend, twist or stretch the hose.

Note: Make sure the hose clamp is properly fixed to avoid loose connection. Improper connection of the gas hose might result in gas leakage and possess danger.
- Avoid placing the gas cylinder near the cooker.

Opening Dimension

The counter top cut out dimension should be A X B (mm).



Model	Cut Size(AxB)
VGH-228 2B-BK	630X320

OPERATING INSTRUCTIONS

Ignition operation

1. Put all the knobs in the "OFF" position, and then open the main air supply valve.
2. Press the knob, and turn the knob counterclockwise to the high fire position, the ignition needle will make a "click" sound, and the flame will automatically ignite.

note

1. When igniting, press the knob firmly to the end and rotate it to the left. After a fire, you still need to press the knob for 3-5 seconds before letting go to avoid
2. Let go of the flame (the stove flameout protection system needs to be preheated for 3-5 seconds).

Tips

1. The stove is used for the first time or used again after a long period of non-use, due to the residual air remaining in the gas channel, it will cause difficulty in ignition, which is normal. Please try to ignite several times to exhaust the residual air until it can be ignited normally. It is strictly forbidden to remove the air pipe and directly exhaust.
2. The ignition time of the stove must be less than 8 seconds each time to avoid deflagration;
3. If the ignition fails for 3 consecutive times, the ignition must be stopped immediately, and the window must be opened for ventilation for a period of time. After the gas in the air diffuses to the outside, the ignition will continue to prevent the outflow of gas from accumulating excessively and causing an explosion or other accidents.

Flameout operation

Rotate clockwise to the "Off" position. After hearing a "click", the gas is cut off and the flame of the gas stove goes out.

Tips

If the burner of the stove is accidentally turned off, the safety valve of the stove will automatically cut off the gas source. If you want to use the stove again, you must turn all the knobs to the "Off" position, and then perform the ignition operation.

Flame adjustment method

Press the firepower mark at the knob switch to adjust the firepower of the gas stove at will. The firepower mark of some models may be different from the figure below, and the specific ones shall prevail.

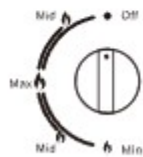

Off

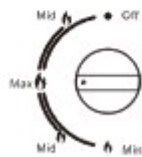

Maximum firepower

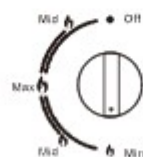

Minimum firepower

CAUTION WHEN USING

1. Only use the cooker for cooking purpose only.
2. Do not hang up clothes, towel etc. to dry on the cooker .
3. Do not use oversized hot plate which totally covers the burner surface.
4. If the flame is flickering, turn off the cooker immediately and check it before operating the cooker
5. Make sure the air and gas mixture is well adjusted and the flame is burning properly.
6. Do not use a large iron plate to cover burners.



7. In case of abnormality, including strange sound, abnormal combustion when the burners are lit, turn off the burners and the gas supply immediately and contact the authorized service technician.
8. When the cooker will not be used for a long period of time, make sure the gas supply is turned off.

CAUTION:"The use of a gas cooking appliance results in the production of heat, moisture and products of combustion in the room in which it is installed. Ensure that the kitchen is well ventilated especially when the appliance is in use: keep natural ventilation holes open or install a mechanical ventilation device (mechanical extractor hood).

Prolonged intensive use of the appliance may call for additional ventilation, for example opening of a window, or more effective ventilation, for example increasing the level of mechanical ventilation where present.

CAUTION: In case of hotplate glass breakage:

- shut immediately off all burners and any electrical heating element and isolate the appliance from the power supply
- do not touch the appliance surface,
- do not use the appliance.