

INSTRUCTION MANUAL

Electric Oven

Model: VEO-65LBK

Spec.: 220-240V A.C., 50/60Hz., 2200 Watts.



HOUSEHOLD USE ONLY

Read all the sections of this booklet and follow all the instructions carefully.

IMPORTANT SAFETY INSTRUCTIONS

When using your *Electric Oven* /Rotisserie /convection, basic safety precautions should always be observed, including the following:

1. Read all instructions.

2. **Do not** touch hot surfaces. Always use handles or knobs.
3. Close supervision is necessary when any appliance is used by or near children.
4. To protect against electric shock, do not immerse cord, plug or any parts of the oven in water or any other liquids.
5. **Do not** let cord hang over edge of table or counter, or touch hot surfaces.
6. **Do not** operate appliance with damaged cord or plug or after the appliance malfunctions or has been damaged in any manner. Return appliance to the nearest authorized service facility for examination, repair or adjustment.
7. The use of accessory attachments not recommended by the appliance manufacturer may cause hazard or injury.
8. **Do not** place on or near a hot gas or electric burner.
9. When operating the oven, keep at least four inches of free space on all sides of the oven to allow for adequate air circulation.
10. Unplug from outlet when not in use and before cleaning. Allow to cool before putting on or taking off parts, and before cleaning.
11. To disconnect, turn the time control to OFF, then remove the plug. Always hold the plug, and never pull the cord.
12. Extreme caution must be used when moving a drip pan containing hot oil or other hot liquids.
13. **Do not** cover any part of the oven with metal foil. This may cause the oven to overheat.
14. Use extreme caution when removing the tray, racks or disposing of hot grease or other hot liquids.
15. **Do not** clean the inside of the oven with metal scouring pads, pieces can break off the pad and touch electrical parts, creating a risk of electric shock.
16. Oversized foods or metal utensils must not be inserted in a toaster oven as they may create a fire or risk of electric risk.
17. A fire may occur if the oven is covered or touching flammable material, including the curtains, draperies, walls, and the like, when in operation. Do not store any item on top of the appliance when in operation.
18. Extreme cautions should be exercised when using cooking or baking containers constructed of anything other than metal or ovenproof glass.
19. Be sure that nothing touches the top or bottom elements of the oven.
20. **Do not** place any of the following materials in the oven: cardboard, plastic, paper, or anything similar.
21. **Do not** store any materials other than manufacturer's recommended accessories in this oven when not in use.
22. Always wear protective, insulated oven gloves when inserting or removing items from the hot oven.
23. This appliance has a tempered, safety glass door. The glass is stronger than ordinary glass and more resistant to breakage. Tempered glass can still break around edges. Avoid scratching door surface or nicking edges.
24. This appliance is OFF when the Timer Control button is in the "OFF" position.
25. **Do not** use outdoors.
26. **Do not** use appliance for other than intended use.

SAVE THESE INSTRUCTIONS

For Household Use Only

Getting To Know Your Convection & Rotisserie Oven

MAIN COMPONENT:

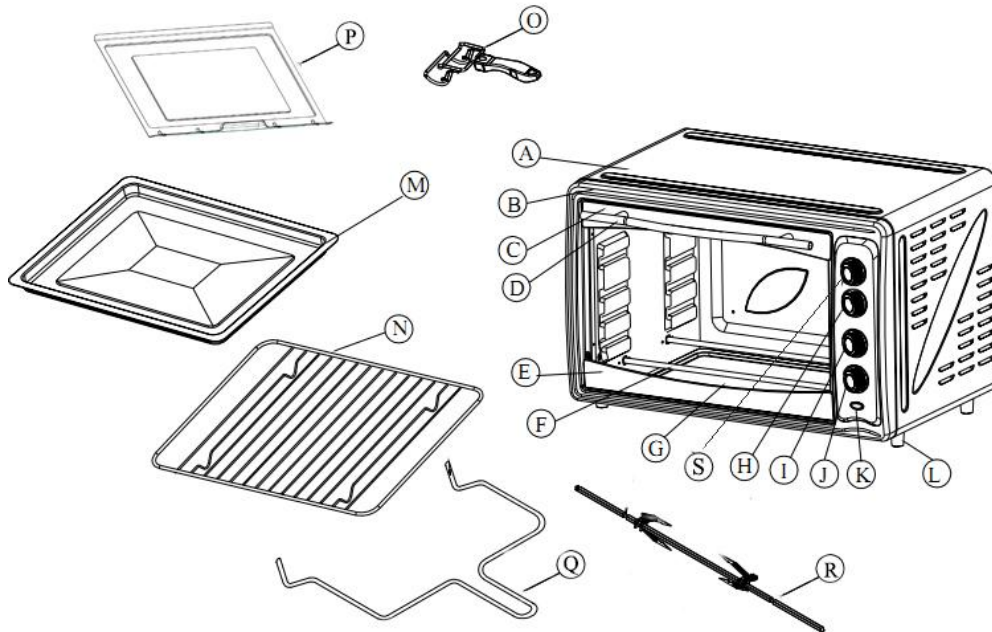

- A: Housing
- B: Front Plate
- C: Upper Door Frame
- D: Handle
- E: Lower Door Frame
- F: Lower heating element
- G: Glass Door
- S: Upper Temperature Control Knob
- H: Function Control Knob
- I: Down Temperature Control Knob

- J: Timer Control Knob
- K: Neon lamp cover
- L: Foot
- M: Bake Tray
- N: Wire Rack
- O: Bake Handle
- P: Crumb Tray
- Q: Rotisserie Handle
- R: Rotisserie set

Technical Specifications

Voltage: 220-240V.A.C., 50/60Hz.

Power: 2200 Watts.

Maximum capacity: 65 litres

With Rotisserie and convection

* Illustrations may differ from actual product. (with optional purchase)

Read all the sections of this booklet and follow all the instructions carefully.

Before using your rotisserie & convection electric oven

▲ Before using your toaster oven with rotisserie & convection for the first time, be sure to:

1. Read all of the instruction included in this manual.
2. Make sure that the unit is unplugged and the **Time control** is in the “OFF” position.
3. Wash all the accessories in hot, soapy water or in the dishwasher.
4. Thoroughly dry all accessories and re-assemble in oven, plug oven into outlet and you are ready to use your new toaster oven.
5. After re-assembling your oven, we recommend that you run it at the highest temperature (250 °C) on the toast function for approximately 15 minutes to eliminate any packing residue that may remain after shipping. This will also remove all traces of odor initially present.



Please Note: Initial start-up operation may result in minimal smell and smoke (about 15 minutes). This is normal and harmless. It is due to burning of the protective substance applied to the heating elements in the factory.

Using your rotisserie & convection electric oven

About Convection Cooking

Convection cooking combines hot air movement by means of a fan with the regular features (broil, bake and toast). Convection cooking provides faster cooking in many cases than regular radiant types toaster oven. The fan gently sends air to every area of the food, quickly browning, crisping and sealing in moisture and flavor. It produces more even temperature all around the food by air movement, so that food cooks/bakes/broils evenly versus the normal ovens hot and cold spots. The convection feature allows cooking/baking at lower temperatures, which saves energy and helps keep the kitchen cooler. Convection air is superheated and it circulates around the food so it cooks food significantly faster than conventional ovens.

Please familiarize yourself with the following oven functions and accessories prior to first use:

- **Upper Temperature Control:** choose the desired temperature from **100 °C** to **230 °C** for baking, broiling or toasting.
- **Function Control:** There are four stages switch for function selector : (Off)/  (Upper heating and convection and rotisserie function)/  (Down heating and convection function)/  (Upper & Down heating and convection and rotisserie function)
- **Down Temperature Control:** choose the desired temperature from **100 °C** to **230 °C** for baking, broiling or toasting.
- **Timer Control:** when you activate the timer segment of the control from 0~60minutes, turn to the right (clockwise) to toast or use as a timer. The timer bell will ring at the end of the programmed time.
- **Power Neon Light:** Illuminated whenever the oven is turned on.
- **Baking Tray:** For use in broiling and roasting meat, poultry, fish and various food. Can also be used when using the rotisserie handle to catch the drippings.
- **Wire Rack:** For toasting, baking, and general cooking in casserole dishes and standard pans. **Note:** To prevent

oil dripping into the heating tube from catching fire, do not use a baking net to directly barbecue meat or food with large amount of oil.

- **Tray Handle:** Allows you to pick up the wire rack, and baking tray when they are hot.
- **Crumb Tray:** For taking out the food crumb by this tray, Note: put this tray under the down heating tube, make sure put it at the bottom of inside oven cavity.
- **Rotisserie Handle:** Allows you to pick up the Rotisserie set, and baking tray when they are hot.
- **Rotisserie Set:** For roasting whole chicken and other foods need rotisserie function.

HOW TO BAKE

- Place the removable rack into the desired position.
- Insert the baking tray and close the oven door.
- Turn the timer knob to the desired cooking time.
- Turn the function selector knob to BAKE .
- Select the down temperature.
- Bell will ring to signal the end of the toast cycle.
- When finished baking, turn the timer to “OFF” position to switch off the oven.

HOW TO BROIL

- Insert the removable bake rack with food and bake tray.
- It is advisable to leave the door slightly ajar.
- Turn the function selector knob to BROIL .
- Select the upper temperature.
- When finished broiling, turn the timer to “OFF” position to switch off the oven.

HOW TO TOAST

- Set the Upper and Down Temperature Control Knob to 230°C.
- Turn the function control knob to TOAST .
- Place food to be toasted on the wire rack.
- Turn the time control knob to the desired cooking time.
- Bell will ring to signal the end of the toast cycle.

Note: Wire Rack should be positioned in the middle of the oven with the indentations pointing down.

Positioning of the Wire Racks

Cookies – Use bottom and middle Support Guides.

Layer Cakes – Use bottom Support Guide only (bake one at a time).

Pies – Use bottom and middle Support Guides.

Note: Wire Rack should be positioned in the middle of the oven with the indentations pointing down



CAUTION: Always use extreme care when removing bake tray, wire rack or any hot container from a hot oven. Always use the rack handle, or an oven mitt when removing hot items from the oven.

Care & Cleaning

Warning: Be sure to unplug the oven and allow it to cool before cleaning.

Any spattering that occurs while cooking and comes into contact with the continuous coating is oxidized while the oven is in operation. If desired, wipe the walls with a damp sponge, cloth or nylon scouring pad and mild detergent.

DO NOT USE STEEL WOOL SCOURING PADS, ABRASIVE CLEANERS OR SCRAPE THE WALLS WITH A METAL UTENSIL, AS ALL OF THESE METHODS MAY DAMAGE THE CONTINUOUS CLEAN COATING.

All accessories should be washed in hot soapy water or can be cleaned in a dishwasher. The door can be wiped with a damp sponge and wiped dry with a paper or cloth towel. Clean the outside with a damp sponge.

DO NOT USE AN ABRASIVE CLEANER AS IT MAY DAMAGE THE EXTERIOR FINISH.

DO NOT USE AN ABRASIVE CLEANER OR STEEL WOOL SCOURING PAD ON THE DRIP PAN AS IT MAY DAMAGE THE PORCELAIN ENAMEL FINISH.

LET ALL PARTS AND SURFACES DRY THOROUGHLY PRIOR TO PLUGGING OVEN IN AND USING.

Warning statement

- a) This appliance can be used by children aged from 8 years and above and persons with reduced physical, sensory or mental capabilities or lack of experience and knowledge if they have been given supervision or instruction concerning use of the appliance in a safe way and understand the hazards involved. Children shall not play with the appliance. Cleaning and user maintenance shall not be made by children unless they are older than 8 and supervised.
- b) Keep the appliance and its cord out of reach of children less than 8 years.
- c) The appliances are not intended to be operated by means of an external timer or separate remote-control system.
- d) If the supply cord is damaged, it must be replaced by the manufacturer, its service agent or similarly qualified persons in order to avoid a hazard.