



- Thank you so much for purchasing this product.
- This product is for family use only.
- Please read this instruction manual carefully before using the product to ensure the correct and safe use of this product.
- **Pay special attention to Safety Precautions. (Page 2-4).**
- Please safekeeping the Warranty Certificate and the User’s manual .

Built-in oven

Instructions for use installation

Family use built-in oven

Model: MO-70MM08FEC

Contents

Safety precautions.....	2 ~4
use precautions.....	4~5
Initial use precautions.....	6
Appliance parts and operation.....	7
● Oven component.....	7
● Accessories.....	7
● Control panel.....	8
● Function settings.....	9
● Cooking knacks.....	10
Usage method.....	11
● Cooking suggestion and instructions.....	11
● Energy saving tips.....	11
Cleaning and maintenance.....	12
● Oven interior /oven door.....	12
● Remove the oven door.....	12
● Remove the slide-in racks.....	13
● Oven light replacement.....	13
● Sensor probe replacement.....	14
● Specifications.....	17
Installation Instructions.....	15~18

The right of final interpretation of the manual belongs to our company.

Safety Precautions

Be sure to observe

To prevent the bodily injury and property damage, please be sure to observe the following safety precautions.

■ The following icons show the extent of damage caused by incorrect operations.



Warning: Indicates a potential hazard that, if unavoidable, may result in death or serious injury.



Note: Indicates a potential hazard that, if unavoidable, may result in death or moderate injury.

The classification and interpretation of icons are as follows.



This icon indicate that cannot be in progress, i.e. “Prohibited” .



This icon indicate that it must be executed, i.e. “compulsory” .



Warning



● Do not use the appliance if the power cord or the power plug has been damaged, or the interface between the power sockets and the power plug is loose.

(To avoid electric shock or fire due to short circuit.)

→If the soft wire of the power supply is damaged, in order to avoid danger, it must be replaced by professionals of the manufacturer, its maintenance department or similar departments.

● Do not damage power cord or power plug.

•The following operations are absolutely prohibited:

Damage, process, make it contact or close to high temperature, force bending, twisting, drawing hanging on the corner, pulling power to move.

(To avoid electric shock due to breakage of power cord and power plug, or fire due to short circuit.)

● Do not use the sealed tank or container in the oven.(In order to avoid the danger of explosion caused by overpressure of containers during cooking.)

● Do not insert anything into the opening of the oven.

•Especially the metal objects, such as lead wire or electric wire.

(To avoid electric shock or injury caused by abnormal movements.)

● Do not install the decorative door panels in front of the oven.

(To avoid the door panels become deformed caused by overheating.)

● Keep away from the appliance while in use or just after use. Pay special attention to children.(To avoid scalds)

● Do not place objects other than heat-resistant pottery in this product.

(To avoid fire caused by high temperature melting.)

Prohibition example:

•Flammable objects such as plastic containers.

•Articles made of aluminium foil, etc.

● Do not use this appliance to heat the room.

(To avoid causing fire and shortening product life.)

● Do not use this appliance to heat unopened canned products.

(To avoid fire, scald or injury cause by explosion due to pressure accumulation.)





Warning



- Do not alter, disassemble or repair the product by yourself. (To avoid causing fire, electric shock or injury.)
For repairs, please contact (Company name) Certification Maintenance Store for consultation.
- Do not clean the oven door glass with a rough scrubber or sharp scraper.
(In order to avoid scratches on the surface of glass, resulting in glass crushing.)
- Be sure to use AC power sockets with specifications of AC220V-240V/16A separately.
(In order to avoid fire caused by heating when used with other electrical appliances.)
Be sure to use the wiring boards with specifications of at least 16A.
- Be sure to plug the power plug into the bottom of the socket.
(In order to avoid causing smoke, fire or electric shock.)
- This product should be properly connected to the grounding system in accordance with national and local safety regulations.
(To avoid the risk of electric shock in case of malfunction or leakage.)
- Users must test this basic security requirement. If there is any doubt, it should be test the home power supply system by the qualified electrical technicians.
- Make sure that the product is installed correctly and all electrical components are installed correctly before use.
(To avoid causing fire or injury.)
- This product is not suitable for following persons (including children) :persons with reduced physical, sensory or mental capabilities or lack of experience and knowledge if they have been given supervision or instruction concerning use of the appliance in a safe way and understand the hazards involved. Children shall not play with the appliance. Cleaning and user maintenance shall not be made by children without supervision.
(To avoid burns, injuries or electric shocks.)
- Make sure that the packaging (such as food preservation film, polystyrene and plastic packaging materials) that may be produced during the use of the appliance are placed out of the reach of children.
(To avoid suffocation caused by eating wrong.)
- In case of abnormal or malfunction, please stop using and pull out the power plug immediately.
(To avoid causing smoke, fire or electric shock.)
Abnormal breakdown case
Abnormal fever of power plug and power cord.
The power cord has been damaged or intermittent power failure occurs after touching the power cord.
Abnormal fever of the appliance.
The appliance smokes or gives off a burning smell.
The appliance breaks, loosens or makes a noise.
Please contact (Company name) Certified Maintenance Shop immediately for consultation, inspection and repair.
- When installing, maintaining and repairing this appliance, make sure to disconnect the power supply.
(To avoid electric shock or injury.)
Under the following conditions, the product must be completely disconnected from the power supply.
The master fuse has been disconnected.
The twist fuse has been removed (countries that apply only to this situation).
The wall socket has been turned off and the power plug has been pulled out.
- Make sure to turn off the power supply before changing the light .(To avoid electric shock.)
- Before the first use, please burn it empty to remove the odor. (See the appendix [Initial use precautions])
(Not to affect the normal use of the appliance.)
- Remove packing parts and cushioning materials before use.(To avoid fire causing by temperature raising)

Note

-  ● Do not put inflammable materials in the oven.
(So as not to cause a fire when accidentally turning on the oven)
- Do not sit or fall back on open products.
(To avoid damaging the telescopic chute.)
- Do not use irritating, corrosive cleaners or sharp metal scrapers to clean glass doors of oven.
(To avoid scratching the surface, or even causing glass to break.)
- Do not use steam cleaner to clean this product.
(To avoid short circuit or product failure.)
- Do not touch the bottom of the product after the power is turned on.
(To avoid scalds.)
-  ● During cooking the food with fat or oil release, be sure to be watched by someone.
(To avoid causing fire.)
- When pulling out the power plug, make sure to hold the plug .
(To avoid electric shock or fire due to short circuit.)
- Do not replace your hands on either side of the door when it closes.
(To avoid injuries caused by clamping fingers when closing the door.)

Use Precautions

Focus on product

- Before the first use, please remove all the protective film on the product (except rating label).
(To prevent the protective film from melting due to high temperature and scalding after touching.)
- Before first use, please remove packaging material from the oven.
(Grill, cardboard on both sides of the baking tray, cushioning foam in front and rear of the grill and strapping tapes on the slide rail).
- During operation, the oven become very hot, and heat-resistant gloves should be worn when operating.
(To avoid scalds.)
- During operation, the oven door must be closed and confirm there is no object stuck on the oven door.
(To avoid affecting the cooking effect.)
- Do not leave sugary food residues (such as jam) in the oven.
(To avoid damaging the enamel inside the oven.)
- Do not use plastic products in the oven.
(To avoid the melting of plastic will damage the oven cause by high temperature.)
- During using the oven, do not cover the bottom of the oven with aluminum foil, tin foil, or place pans and baking tray at the bottom of the oven.(To avoid damaging the enamel inside the oven.)
- During using the oven, if the surface is still very hot, do not water the baking pan directly.
(In order to avoid steam burn out or damage the enamel surface.)
- Do not use spray cleaner.
(Avoid causing insulation aging ,thereby damaging the oven.)

Use Precautions

Slide-in racks Placement Warning

In order to ensure the safe use of the grate or tray, it is necessary to insert in the right direction and place the slide-in racks correctly.

In addition, you can also refer to the level number displayed in the front of the oven when you open it. (There are five levels altogether.)

This ensures that food does not slip out of the back during careful removal from the grate or tray.

Before closing the oven door, make sure that the grate (baking tray) is in place and that the grate (baking tray) does not touch the glass inside the oven door.

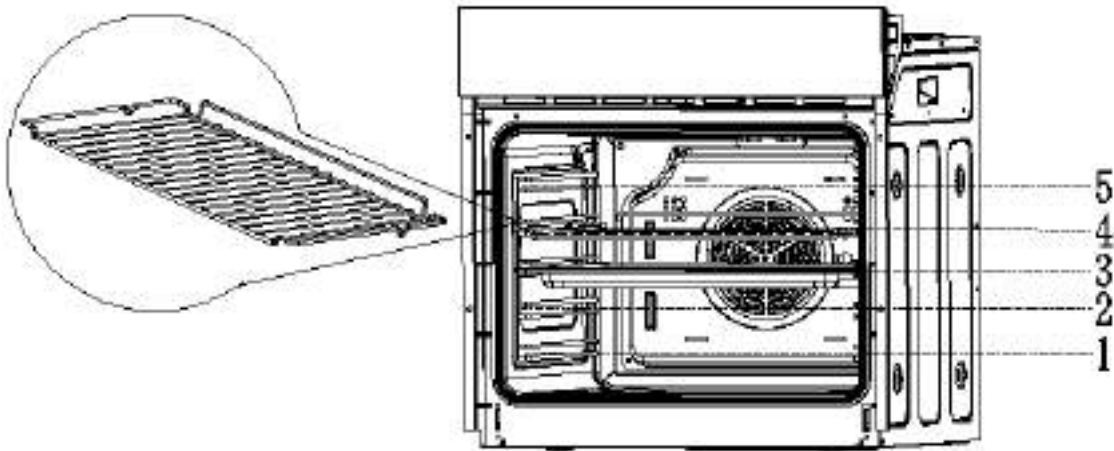

Removal of Packaging Components and Cushioning Materials

Remove packaging materials before use

Before the initial use, please remove the packing material according to the drawing first, the other operations can be carried out.

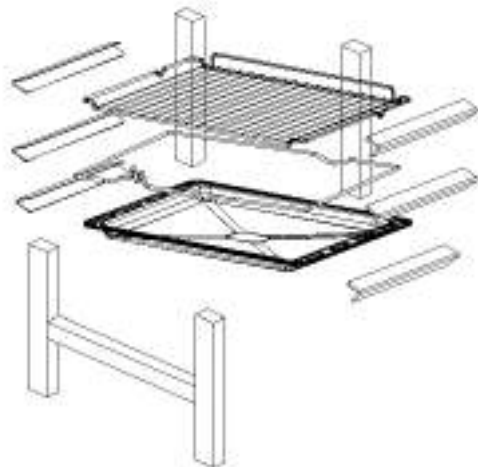

Please pay attention to remove the packing materials in the oven

Initial Use Precautions

Note: When using oven for the first time, there may be a small amount of smoking and odor, which is a normal phenomenon. Please adjust the temperature of the empty oven to 250 °C , and bake it with stereoscopic function for 30 minutes before using it.

Initial Use Operation

- 1 Remove all cushioning material

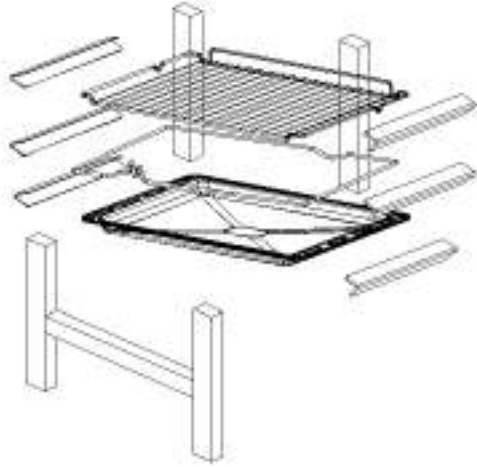

- 2 Operate the empty oven for about 30 minutes with top and bottom heat mode and maximum temperature.
- 3 The resulting typical smell of a brand is unavoidable. Please ventilate the room.

Appliance parts and operation

Oven Component

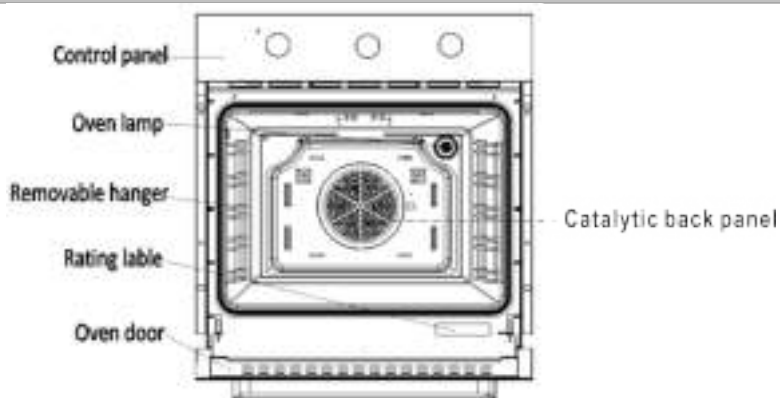

Accessories

- Before first use, please clean all accessories and use soft cloth and neutral detergent to clean the oven.
- Only original accessories can be used.



- ◆ Grate
Used for baking and barbecuing



- ◆ Enameled baking tray
Used for cooking large amounts of food, such as damp cakes, pastries, frozen foods, or for collecting fat/spills and gravy

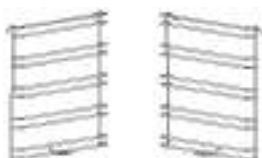

- ◆ Slide-in racks
When cleaning the oven wall, the racks on both sides can be removed.



- ◆ Rotisserie spit
comprises a spit, 2 prongs, a removable handle and a cradle, which fits into the 3rd shelf from the bottom. To use the rotisserie, fit the spit into the hole in the rear wall of the oven's interior. Place the baking tray on level 1 when using the spit.



- ◆ Back catalytic
Easy to clean.



- ◆ Screw assembly
Screws (2) for fixing product

Appliance parts and operation

Control Panel

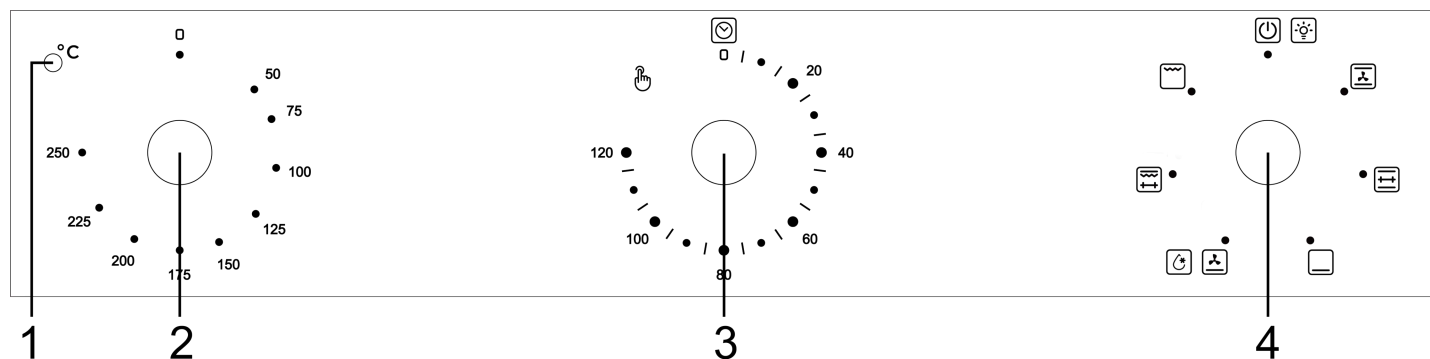

1. Indicator light

(indicates the heating process, i.e. the operation of one or more heating elements)

2. Temperature setting knob

- Rotate the knob to select the desired temperature.

3. Timer setting knob

- Rotate the knob to select the desired cooking time. When the set time is reached, the oven stops working.

The bell rings and the lamp turns off automatically. The  in the timer setting knob is the stay on function,

rotate counterclockwise to the  icon, the oven stays working.







4. Function setting knob

- Rotate the knob to select the desired function.



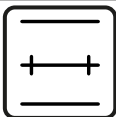
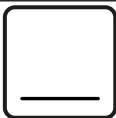

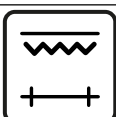



Appliance parts and operation

Function Settings

Turn the knob to the relevant icon and select the cooking functions required.

Icons	Function Description
	<p>Lamp</p> <p>Users can observe the cooking progress without opening the door, but they need to start the setting function and then the lamp will turn on.</p>
	<p>Conventional+fan</p> <p>The combination of fan and two heating elements can provide more uniform thermal penetration performance and save 30-40% energy. The outside of the food is slightly brown but the inside is still wet. Note: * This function is suitable for high temperature roasting or roasting large pieces of meat.</p>
	<p>Conventional + Rotisserie</p> <p>The top and bottom work together, and can be used for routine cooking operations.</p>
	<p>Bottom heat</p> <p>The concealed element at the bottom of the oven provides more concentrated heat without browning. This is suitable for slow cooking dishes, such as crisp casseroles, stews, pastries and pizza.</p>
	<p>Bottom heat+fan</p> <p>The rear fan and the lower heating element can work at the same time. The temperature can be set in the range of 50°C to 250°C.</p>
	<p>Defrost</p> <p>At room temperature, air circulation can quickly thaw frozen food (without any heat). This is an easy control and fast way to speed up defrosting time and thawing process for ready-made vegetables and butter-filled foods.</p>
	<p>Double Grill + Rotisserie</p> <p>The upper inner ring heating element and the outer ring heating element can work at the same time. The temperature can be set in the range of 50°C to 250°C.</p>
	<p>Radiant grill</p> <p>The upper inner ring heating element working. The temperature can be set in the range of 50°C to 250°C.</p>

Cooking Knack

Food	Weight (kg)	Level	Function Setting	Temperature in °C	First Face(minutes)	Second Face(minutes)	Accessory
Biscuit	0.5	3		200	10-15	-	baking tray
Sandwich	0.2	3		180	15-20	-	grate
Swiss Roll	0.2	3		180	10-18	-	baking tray
Small cake	0.3-0.4	3		185	20-25	-	baking tray
Sponge cake	0.5	3		175	30-35	-	grate
Pizza	0.35	3		200	10	-	baking tray
Apple pie	1.2	3		185	50-60	-	grate
Toast	9pcs	5		240	1-2	-	grate
Hamburger	1	5		240	10-20	5-10	baking tray

Cooking Suggestions and Instructions

■ Normal Suggestions

- We suggest to preheat the oven before the food is put into the oven.
- Normally, it is impossible to shorten the cooking time by increasing the temperature (food may be well cooked outside, but not yet inside).
- If cooking is done on a multi-layer grill, we suggest using a Conventional + fan function so that uniform cooking can be achieved at all heights.
- In order to achieve the best cooking effect, we suggest that the suitable ware should be placed in the center of the grill or tray.
- In order to prevent the formation of excessive condensation beads on the inner glass, after cooking, hot food should not be placed in the oven for a long time.

■ Suggestions on meat cooking

- The cooking time of food, especially meat, varies with the thickness and quality of the meat and the taste of the user.
- We suggest using meat thermometers when cooking meat. (The thermometer is not supplied with the oven.)
- If necessary, food can be wrapped in aluminum foil for cooking to make the food more tender.

■ Suggestions on cake and biscuits cooking

- Dark metal molds can absorb heat better when baking cakes.
- Temperature and cooking time depend on the quality and consistency of the mixture.
- To check the cake is ripe or not, at the end of cooking time, insert the metal pole to the top of the cake and then withdraw. If the batter does not stick to the metal pole, the cake is ripe.
- If the cake collapses when it comes out of the oven, the next you can extend the time appropriately, if necessary, can also be reduced by about 10°C for baking.

Energy saving tips

In order to save energy in the use of ovens, the following instructions can be followed:

1. The door must be completely closed for all cooking operations.
2. Please don't open the oven door frequently while cooking, because it will let the heat out of the oven.
3. Turn off the power completely when not in use.
4. Always keep the Oven interior clean.

Cleaning and Maintenance

Oven Interior/Oven Door

■ Oven door

Glass door should always be clean, to remove stubborn stains with kitchen absorbent paper, wet sponges and common detergents.

- Do not use a steam cleaner to clean the oven.
- Do not use detergents or corrosive detergents to clean glass door.
- Do not use rough or friction materials or sharp metal scrapers to clean the oven glass door, as they may scratch the surface.

■ Oven Interior

In order to maintain the oven better, after cooking, the oven should be fully cooled before cleaning.

- Take out all removable parts.
- In order to facilitate cleaning, the oven door can be removed. (Removal method refers to "Remove the oven door" below.)
- Steam cleaners should not be used when cleaning.

Remove the Oven Door

Removable oven door allows users to fully touch the oven interior, making maintenance more convenient and fast.

- ① Open the door to the maximum angle and pull the lock back at the hinge of the door (Figure 1). There are two locks on both sides of the oven door.
- ② Close the oven door, at about 15 degree, then lift the door, and slowly pull out from the oven. (Figure 2)
- ③ After cleaning, perform the above-mentioned operations in the opposite steps to restore the door to its original condition.

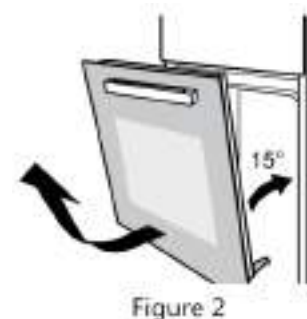
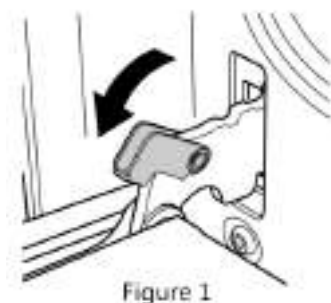

- Note: After using a specific detergent, run the oven for 15-20 minutes with maximum heating settings to remove residues in the oven. In this process, touchable parts may be hotter than usual. Keep children away from the oven.

Remove the Slide-in racks

Remove the hanger to facilitate cleaning the side wall of the oven. Note: Operate this process must by hand slightly, or it will damage the enamel.

- Remove all accessories such as grate and baking tray.
- Slightly push down the hook in racks at the clamping point as shown (A).
- Swivel the rack inwards to an angle of approx. 45 degrees(B-C).
- Unhook it at the top and carefully pull it out (C).
- To reinstall after cleaning, follow the steps above in reverse order.

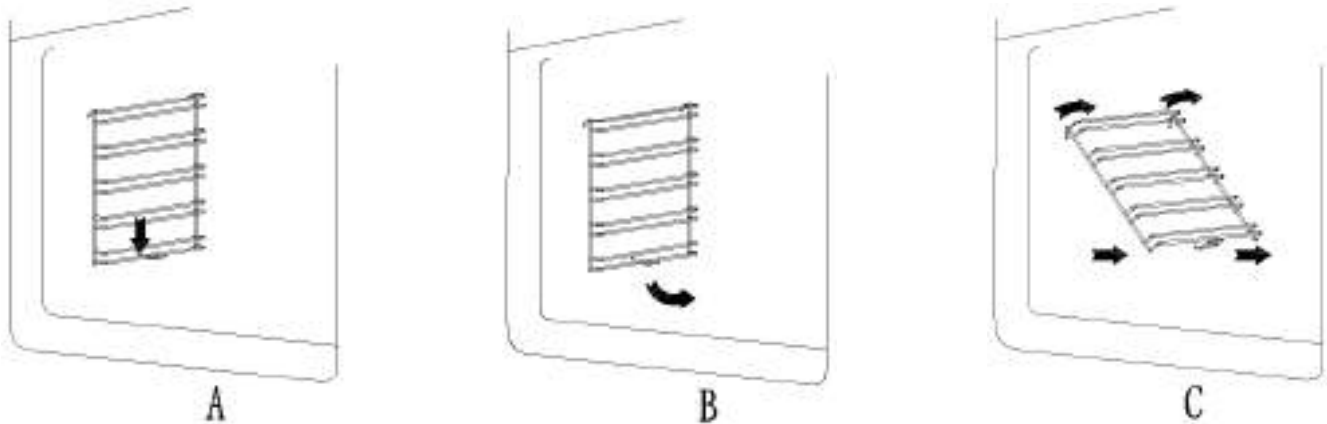

After cleaning, perform the above-mentioned operations in reverse steps to restore the components to their original positions.

Oven Light Replacement

The light used in oven is a special high temperature resistant light (AC220V/25W).

Therefore, it is necessary to purchase genuine light from authorized distributors.

The replacement steps are as follows:

- 1.Disconnect the power supply of the power socket.
- 2.Turn the glass cover counterclockwise.(Figure 5)
- 3.Remove the light and replace it with the same type.(Figure 6)
- 4.After replacing the light, screw the glass cover clockwise.



Figure 5

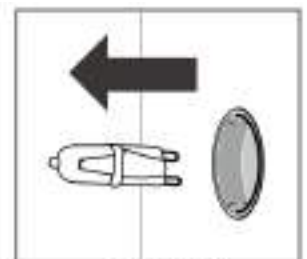

Figure 6

Sensor Probe Replacement

The probe used in the oven is a mechanical physical probe. Do not replace it without authorization. In case of abnormal temperature sensing of the sensor probe, please contact the designated repair shop immediately for replacement.

Specifications

The standby power is about 0.5W when the power supply of the product is "off".

Model	MO-70MM08FEC
Voltage	220-240V
Rated power	2200W
Upper Outer Ring Heat Pipe	1000W
Upper inner heating pipe	1200W
Lower heating tube	1000W
Rated frequency	50/60Hz
Product size(width * depth * height)	595(width) X565(depth) X595(height)
Rated volume	70L

Important note

- The kitchen cover must be suitable to ensure that the oven works properly.
- The panel of kitchen equipment adjacent to the oven must be made of heat-resistant materials. Kitchen equipment made of plywood shall ensure that the glue can withstand a temperature of at least 120 degrees Celsius. When plastic or glue cannot withstand this temperature, the equipment will melt and deform.
- Once the oven is placed in the kitchen equipment, the electrical components must be completely insulated. This is a statutory safety requirement.
- All furnace covers must be firmly fixed in place and cannot be removed without using special tools.
- Remove the back of the kitchen equipment to ensure the full circulation of air around the oven.
- The oven rack must have at least 45 mm rear clearance.
- Because oven handle and sheet metal parts are easy to cut, installers need to wear gloves for installation.

Electrical Connectors

Warning

 The wiring of oven must be equipped with all-pole disconnection device according to the wiring rules.

 After installing the appliance, it is necessary to have other methods to disconnect the power supply. The power supply is disconnected by a contactable plug or by a fixed wiring switch that meets the wiring requirements.

Important information

The appliance is designed to be permanently installed with a three-pin power cord and may only be connected by a licensed expert in accordance with the connection diagram.

Only a qualified electrician who takes the relevant regulations into account may replace the power cord.

Do not use multiple plugs, power strips or extensions. Overloading causes a risk of fire.

If the connection is no longer accessible following installation, an all-pin isolating switch with a contact gap of at least 3mm must be provided.

Connect the wires of the mains power cord in accordance with the following colour coding:

- | | |
|------------------|--|
| Green and Yellow | Earth wire  (E) |
| Blue | Neutral wire (N) |
| Brown | Live (L) |



Great Britain and Australia:

Do not connect the appliance using a 13 A plug or protect it with a 13 A fuse. The appliance must be protected using a fuse that is rated 16 A or higher. The appliance must be disconnected from the power supply during all installation work . When the appliance is installed , protection must be provided against accidental contact in the future.

Reasonable Fixed Oven

Note

Two persons are required to assist in the installation of the oven.

The oven base must be installed as shown below.

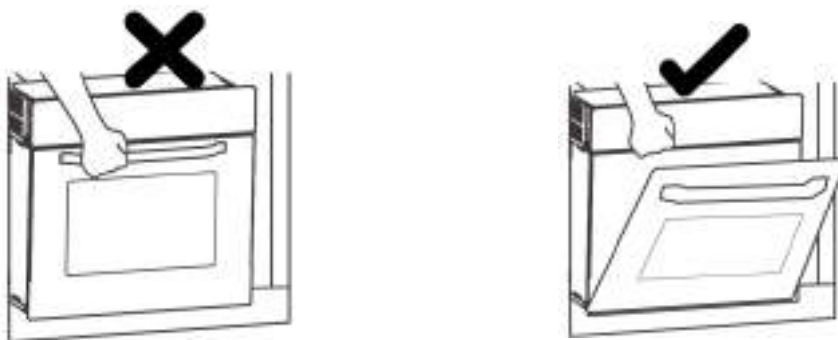

1. Pay attention to the general dimensions required for installation.



Unit:mm

2. Convex

In order to have the best integration of the kitchen, please install the equipment into the standard 600 mm wide cabinet, so it can achieve a flush effect with the front of the cabinet. The equipment can also be installed in the form of convex.

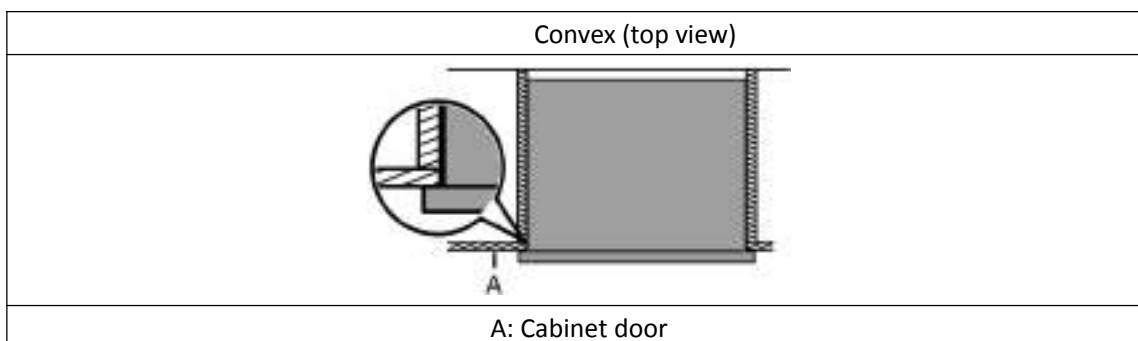

Installation Instructions

For installation personnel

1. Before installing the equipment, please ensure that the cabinet meets the following internal empty dimensions. To ensure air circulation, the oven must be installed in accordance with the size and distance shown in the figure below.

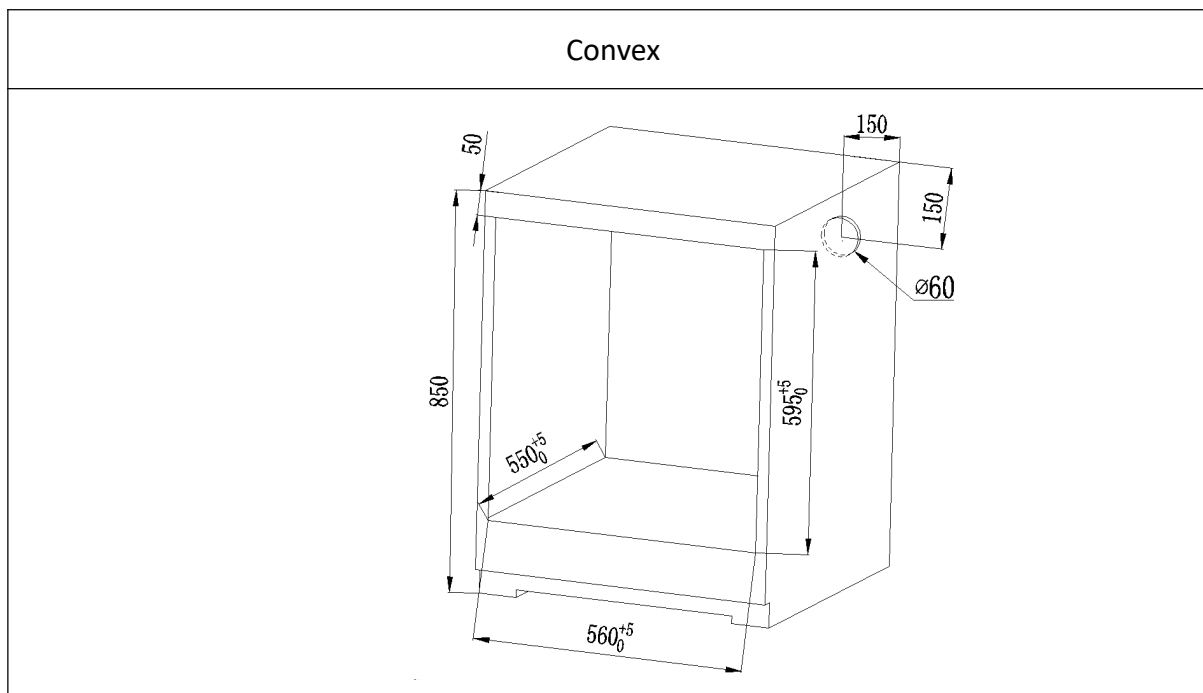

- Note: •The oven can be installed in any cabinet with heat resistance.

Fix Oven to Cabinet

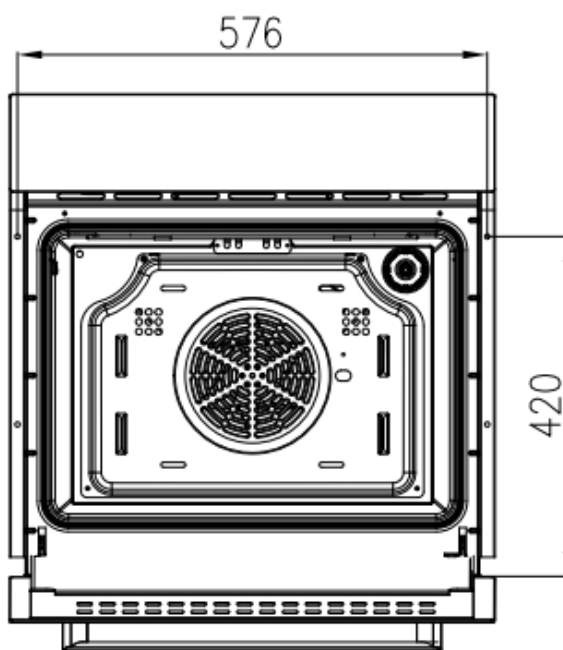

- Note: •Open the oven door, check the side rack of the oven and determine the fixing hole.

Vees Kitchen Appliances Sdn. Bhd. (1399548-P)

F-06-03, Setiawalk, Pusat Bandar Puchong, 47160 Puchong, Selangor, Malaysia.

Service Hotline: 03-86001648