

vees®

DUO-UNIQUOKER™ | HL-310S

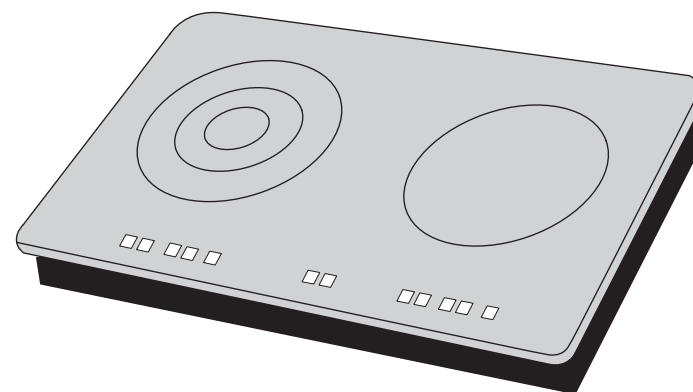

User Manual

Please read these instructions carefully before use and keep them for future reference.

vees®

Veas Kitchen Appliances Sdn. Bhd. (1399548-P)

F-06-03, Setiawalk, Pusat Bandar Puchong, 47160 Puchong, Selangor, Malaysia.

Service Hotline: 03-8600 1648

www.vees.com.my

Disclaimer:

The company in publishing and printing of this manual has done its best to ensure that all informations and its contents are correct, if there are errors or omissions, we shall not be held responsible. In addition, with respect to any technical improvement of the product, the information will be given in the revised edition of the manual.

Warranty

1. During the one-year warranty period (based on receipt date), though users are operating the HL-310S in accordance with instructions given in the manual, fault is still found in the HL-310S, the company will provide free repair.
2. To enjoy the free maintenance service, users must produce official receipt.
3. During the warranty period, in the event of any incorrect use and the failure to produce receipts, a reasonable and appropriate maintenance fee will be charged.
4. The company will provide maintenance services in respect of the fault occurred after warranty period, and will charge a reasonable fee.
5. Users are not entitled to free replacements and are not under warranty service when the followings occur:
 - a. Glass and decorative items;
 - b. Damage due to human error or incorrect use;
 - c. Damage due to errors, improper use or accident;
 - d. Damage occurred after the prescribed time limit.
6. Before calling the Customer Service Centre for assistance, please check the fault yourself first and find out the cause.
7. Please provide the product information to the Customer Service Centre. The information may be found from the surface and bottom of the Uniqooker or documents in the package. With respect to damage caused by incorrect use or fault, our service centre will charge a reasonable and appropriate fee.
8. Our products comply with the current safety standard of household appliances and can only be maintained by qualified technicians. **WARNING!** Please do not modify the internal structure of the HL-310S.
9. Return shipping for warranty / service work is the customer's responsibility cost for shipping while back to the customer is covered by Veas within the Continental Wilayah Persekutuan Malaysia. Any expedited shipping will be at the owner's expense.

Troubleshooting

The faults	Inspection and management
The Uniqooker not heated, the display screen is off.	Whether the power is turned on? Whether the plug is inserted properly? Whether the socket is damaged? Whether all the burners are having the same problem?
Circuit breaker trips when power is on.	Whether the use of power exceeds the power rating?
Power light flashes, then the light is off.	For cooking at high power for a long period, the Delicooker will start its automatic protection device to avoid overheating of internal components. When the light stops flashing, the user can continue to use it.

Working Principles

A Induction Hob

An Induction Hob uses induction heating for cooking. An electric current flows through the copper wire coil, which produces magnetic field. This field induces an electric current in the pot, and produces heating which heats the food. Only cookware made of ferromagnetic metal can be used on Induction Hob.

B Hi-Light Ceramic Hob

A Hi-light Ceramic Hob uses heating plate to heat up the hob surface, which then heats the cookware and the food. Therefore, all types of cookware can be used on Hi-Light Ceramic Hob.

C Over-Temperature Protection

HL-400K-G is equipped with a temperature sensor device to monitor the temperature inside the hobs. When an excessive temperature is detected, both the Induction Hob and the Hi-Light Ceramic Hob will stop increasing temperature automatically.

D Detection of Small Articles (Induction Hob)

When the Induction Hob detected the existence of a pot which is less than 80mm in diameter or small articles (e.g. knife, fork, forceps, key, etc.) or non-magnetic pots (such as aluminum or bronze pot), the buzzer can give out an alarm lasting about 1 minute. In case user has not put proper pot in time, the Induction Hob shall automatically switch to standby mode.

E Heat Remains After Used

When the hob is used for a long period of time, heat remains in the heating zone for a few minutes.

F Auto Shutdown Protection

Auto shutdown is a safety protection function for HL-400K-G. If not turned-off after 30 minutes, it will shut down automatically. When pot is removed, the Induction Hob shall stop heating immediately and shut down after 1 minute of buzzer sound.

CAUTION!

1. This appliance is for household use / cooking. Children or elderly should not operate the appliance without supervision of competent user for safety purpose.
2. Patients with hear pacemakers shall use this product under guidance of their doctors.
3. Do not touch the hob surface right after removing the pot, since the hob surface will still be very hot.

Product Specifications

VEES HL-310S

Rated Voltage	Rated Power	Diameter of Heating Area
220-240V~ 50/60Hz	3100W with power share left zone max power:2300W right zone max power:2500W	Induction Hob : 200mm Hi-Light Ceramic Hob : 200mm

Power Connection & Installation

For first time use of this product, users must ensure that the household appliance system is connected to earth wire and is in compliance with safety regulations. The HL-310S must be installed by qualified personnel or technicians.

The manufacturer and distributors are not responsible for damages caused by inappropriate usage and incorrect installation.

Installation

Cut out holes on table surface according to the sizes shown in drawing.

For purpose of installation and use, a minimum of 55mm space shall be preserved around the hole.

Be sure the thickness of table surface is at least 30mm. Please select heat-resistant table material.

HL-310S

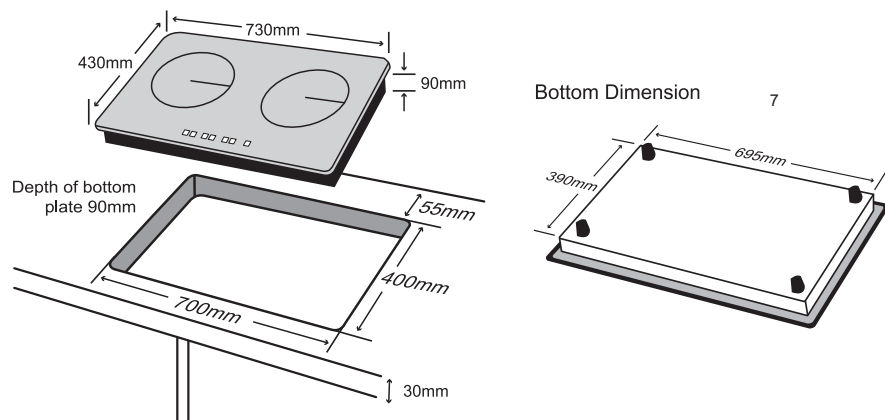

CAUTION!

A safe distance of more than 760mm between the surface of the HL-310S and a cabinet should be kept.

Common Possible Damage

These common damages shall not affect any function of the HL-310S :

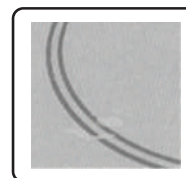

Rust

The rusty surface may be caused by sugar or food which has high-sugar contents.



Scratches

Scratches may be caused by grains of salt, sugar, sand or abnormal bottom of pot.



Fading

Abrasion of metal ring on hob surface or use of unsuitable cleaning products may cause fading.

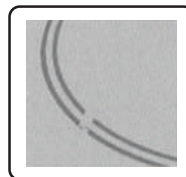

Fading of Decorative Marking

Using unsuitable cleaning products will cause fading of decorative marking.

- The above mentioned damages are caused by incorrect usage and incorrect care of the product and are not related to technical defects, therefore they are not warranted.

Non-Usable Pans

Non-usable Pans for Induction Hob:

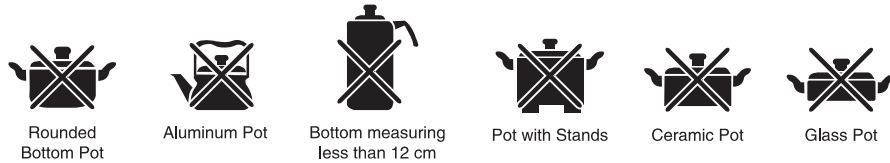

Daily Maintenance

Please clean Delicooker after each use. Before cleaning, please ensure that the hon surface is not HOT.

Cleaning	The high voltage or whiff style steam cleaner should not be used for cleaning. After each use, wipe the cooking surface with a damp cloth then use protective detergent to maintain the brightness of glass panel.
Bottom of pot	Examine the bottom of pot before using. The bottom of pot should not be rough or else is scratch the hob surface.
Hot cookware	Never put hot cookware on top of the control panel.
Salt, sugar and sand	Salt, sugar and sand that are left after cooking should be cleaned to prevent scratches on the hob.
Hard and sharp objects	The hob surface may be damaged by dropping of hard and sharp objects. Keep hard and sharp object at proper places.
Improper cleaning detergent	Never use steel brush or causticity cleaning product such as spray and rust cleaning products to clean the hob.

Safety Guide



For indoor use and home use only



Never cook food while it is in can in order to avoid explosion dangers



Keep out of reach from children. Do not let them use e-Stove without supervision



Any service or replacement of power cord must be performed by technical service department in order to avoid hazard



Never wash by pouring water directly to avoid danger



Never operate Uniqooker in high temperature environments such as near a gas stove or kerosene stove



Do not put any detergents or flammable materials around or beneath Uniqooker



If the surface cracks, switch off the electricity immediately and contact the customer service center



After used, the corresponding heating zone is still hot. Never touch the ceramic surface to avoid burning. Children should keep a safe distance during and after cooking. While the glass surface is hot, wires must not be in contact with the hob surface, otherwise, power cord and cooking area would be damaged



Metallic objects such as knives, forks, spoons, lids and food packed in aluminum foil should not be placed on the hob surface since they can get hot easily and may be flammable

• Overheated Oil

Do not arbitrarily leave oil or oiled foods on the hob surface, since oil could be overheated and produce fire. If fire is caused by oil, do not put off fire by pouring water onto it. Place a lid to cover the fire and switch off the power.

• Cooking

Do not place food directly onto hob surface - always cook with a pot.

• Removing hob from kitchen countertop





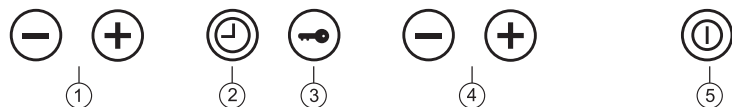



Before removing Delicooker, make sure the electric power has been disconnected.

Indications on Vees HL-310S











- 1 Power (Induction Hob)**
To adjust power required.
- 2 Timer**
This function can be used as time schedule for cooking.
- 3 Locking System**
The lock system is to prevent incorrect operation.
- 4 Power (Hi-Light Ceramic Hob)**
To adjust power required.
- 5 ON/OFF**
The pilot lamp will flickering when the power is on and the Delicooker is on when the button is pressed (at this time, function selection pilot lamp will flickering and is on standby). It shuts down when the button is pressed again.

Instructions to use Induction Hob

- Before using the Induction Hob, put a cookware made of ferromagnetic metal on to the hob surface.
- Touch on , until the indicating lamp is flashing.
- User also can select  and  symbol to adjust the power required.
- If "EO" is seen on indicating lamp, that indicates the Induction Hob failed to detect a ferromagnetic metal cookware, the cookware used is unsuitable. Please use a ferromagnetic metal cookware.
- 5. How to set the timer :**
Assuming the user wants to cook for 45 minutes at level 3, the first thing to do is to touch the timer key , the screen will flash and show **-----**, touch the   to set the cooking time, e.g. 45 minutes. To change the time just touch the  again until the set time is shown. The screen will count down from the set time. Once the cooking time is up, the cooker will beep 4 times. The induction hob will be switched off automatically and the set function will be cancelled.
- If timer is not being set, when the cooking is completed, touch on  symbol to switch off the Induction Hob.
- If timer is being set, display panel will shows wattage. At the end of Pre-set timer, "beep" sound would be heard and Induction Hob will switch off automatically.



Instructions to use Hi-Light Ceramic Hob

- Touch on , until the indicating lamp is flashing.
- User also can select  and  symbol to adjust the heating required.
- 3. How to set the timer :**
Assuming the user wants to cook for 45 minutes at level 3, the first thing to do is to touch the timer key , the screen will flash and show **-----**, touch the   to set the cooking time, e.g. 45 minutes. To change the time just touch the  again until the set time is shown. The screen will count down from the set time. Once the cooking time is up, the cooker will beep 4 times. The hob will be switched off automatically and the set function will be cancelled.
- If timer is not being set, when the cooking is completed, touch on  symbol to switch off the Hi-Light Ceramic Hob.
- If timer is being set, Display Panel will shows wattage. At the end of Pre-set timer, "beep" sound would be heard and Hi-Light Ceramic Hob will switch off automatically.



Safety Lock

The  symbol is sensitive to touch of fingers, HL-400K-G is equipped with Safety Lock to prevent users from switching on/off accidentally.

• Activate Safety Lock

Touch  and hold for 2 seconds, beeping sound will be heard,  indication will light on, it shall lock the function you have selected. If you accidentally touch on other symbols, Delicooker shall not response, except for  symbol.

• De-activate Safety Lock

Touch  and hold for 2 seconds, beeping sound will be heard,  indication will light off, function is unlocked.

Power share function

This induction - Hilight ceramic hob adopts intellectual power distribution technology. when power of a stove is increased and total power exceeds specified value, the system will automatically decrease power pf another stove so as to assure total power is under specified value(3100W).